

E F48-0552 D/S MISC HARNESS

PRODUCTION

PRODUCTION

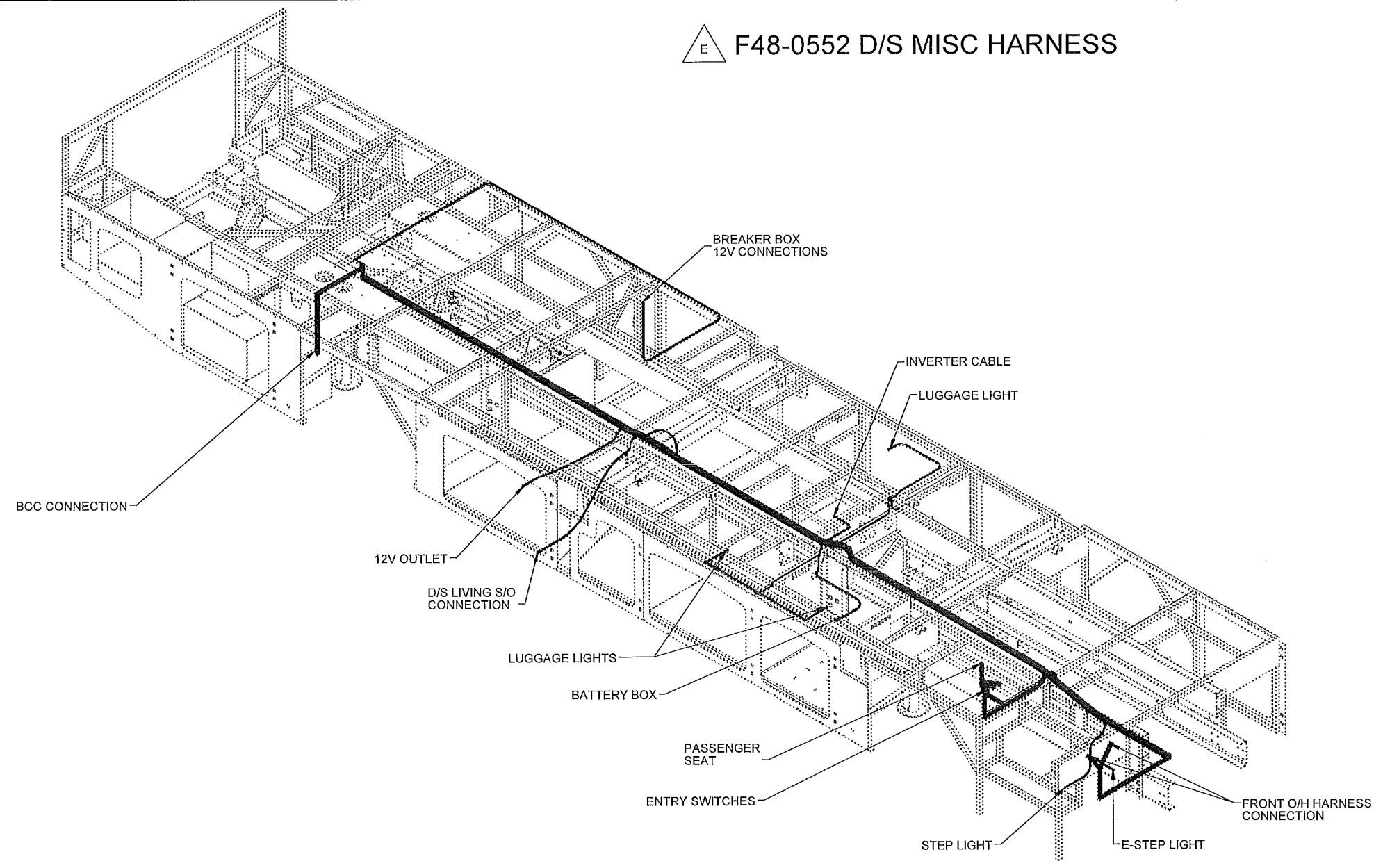

REVISIONS			
REV	DESCRIPTION	BY	RELEASED
E	CHANGED HARNESS PART NUMBERS	044smithm	03/16/15
D	ADDED VANITY LT AND WATER CLOSET LT	044kipfef	03/07/14
B	<<Enter New Revision Description>>	044proffp	+

APPROVALS		
DRAWN	DATE	
Admin	10/15/13	
CHECKED 044smithm	DATE 03/16/15	
ENG APPR. 044smithm	DATE 03/16/15	
BOM APPR. +	DATE +	
DSN APPR. +	DATE +	

PROPRIETARY AND CONFIDENTIAL
 THIS MATERIAL IS PROPRIETARY TO FLEETWOOD RV, INC. AND IS NOT TO BE USED BY THE RECIPIENT FOR ANY PURPOSE OTHER THAN THE PURPOSE FOR WHICH IT WAS TRANSMITTED. THE MATERIAL REMAINS THE PROPERTY OF FLEETWOOD RV, INC. AND SHALL BE RETURNED UPON REQUEST. THE MATERIAL MAY NOT BE REPRODUCED OR DISCLOSED TO THIRD PARTIES WITHOUT THE CONSENT OF FLEETWOOD RV, INC.

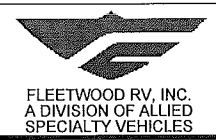

UNLESS OTHERWISE SPECIFIED
TOLERANCES
 X.XX ±.03 FRACTIONS ± 1/32
 X.XXX ±.015 ANGLES ±1°
UNITS OF MEASURE IN 3RD ANGLE PROJECTION

TITLE		HARNESS-12V ROUTING 770-37R	
SCALE	SIZE	DWG NO.	REV
1:384	B	19C00013	E
SHEET		1 OF 9	
FILE		19C00013	



F48-0504 R/S MISC HARNESS

D
C
B
A

D
C
B
A

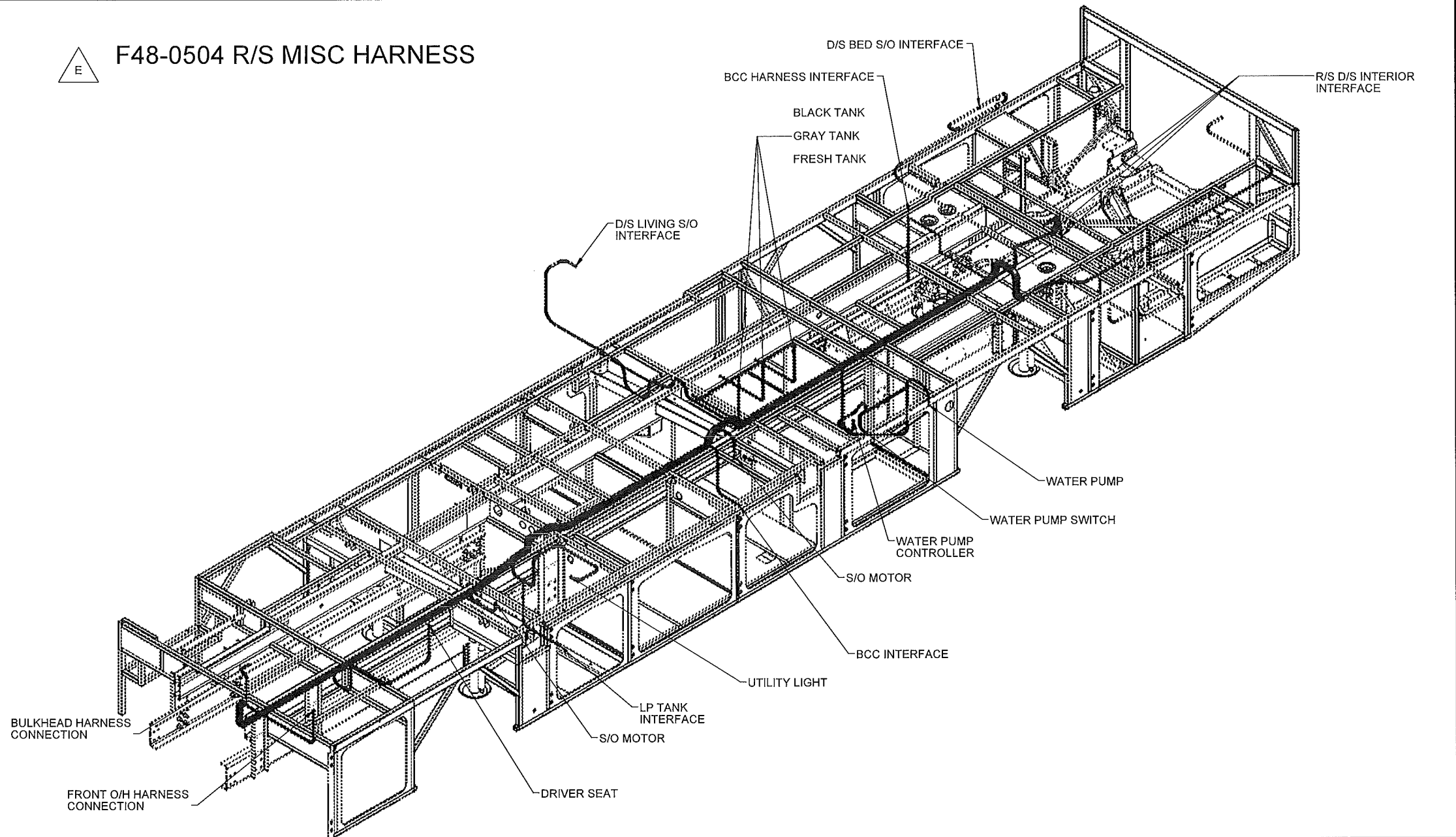

REVISIONS			
REV	DESCRIPTION	BY	RELEASED
E	CHANGED HARNESS PART NUMBERS	044smithm	03/16/15
D	ADDED VANITY LT AND WATER CLOSET LT	044kipfef	03/07/14
B	<<Enter New Revision Description>>	044proffp	+

APPROVALS		
DRAWN	DATE	
Admin	10/15/13	
CHECKED 044smithm	DATE 03/16/15	
ENG APPR. 044smithm	DATE 03/16/15	
BOM APPR. +	DATE +	
DSN APPR. +	DATE +	

PROPRIETARY AND CONFIDENTIAL
 THIS MATERIAL IS PROPRIETARY TO FLEETWOOD RV, INC AND IS NOT TO BE USED BY THE RECIPIENT FOR ANY PURPOSE OTHER THAN THE PURPOSE FOR WHICH IT WAS TRANSMITTED. THE MATERIAL REMAINS THE PROPERTY OF FLEETWOOD RV, INC, AND SHALL BE RETURNED UPON REQUEST. THE MATERIAL MAY NOT BE REPRODUCED OR DISCLOSED TO THIRD PARTIES WITHOUT THE CONSENT OF FLEETWOOD RV, INC.

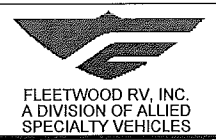

UNLESS OTHERWISE SPECIFIED
 TOLERANCES
 X.XX ± .03 FRACTIONS ± 1/32
 X.XXX ± .015 ANGLES ± 1°

TITLE HARNESS-12V ROUTING 770-37R
 SCALE SIZE DWG NO.
 1:384 B 19C00013

REV E	SHEET 2 OF 9
-------	--------------

PRODUCTION

F48-0223 R/S D/S INTERIOR HARNESS

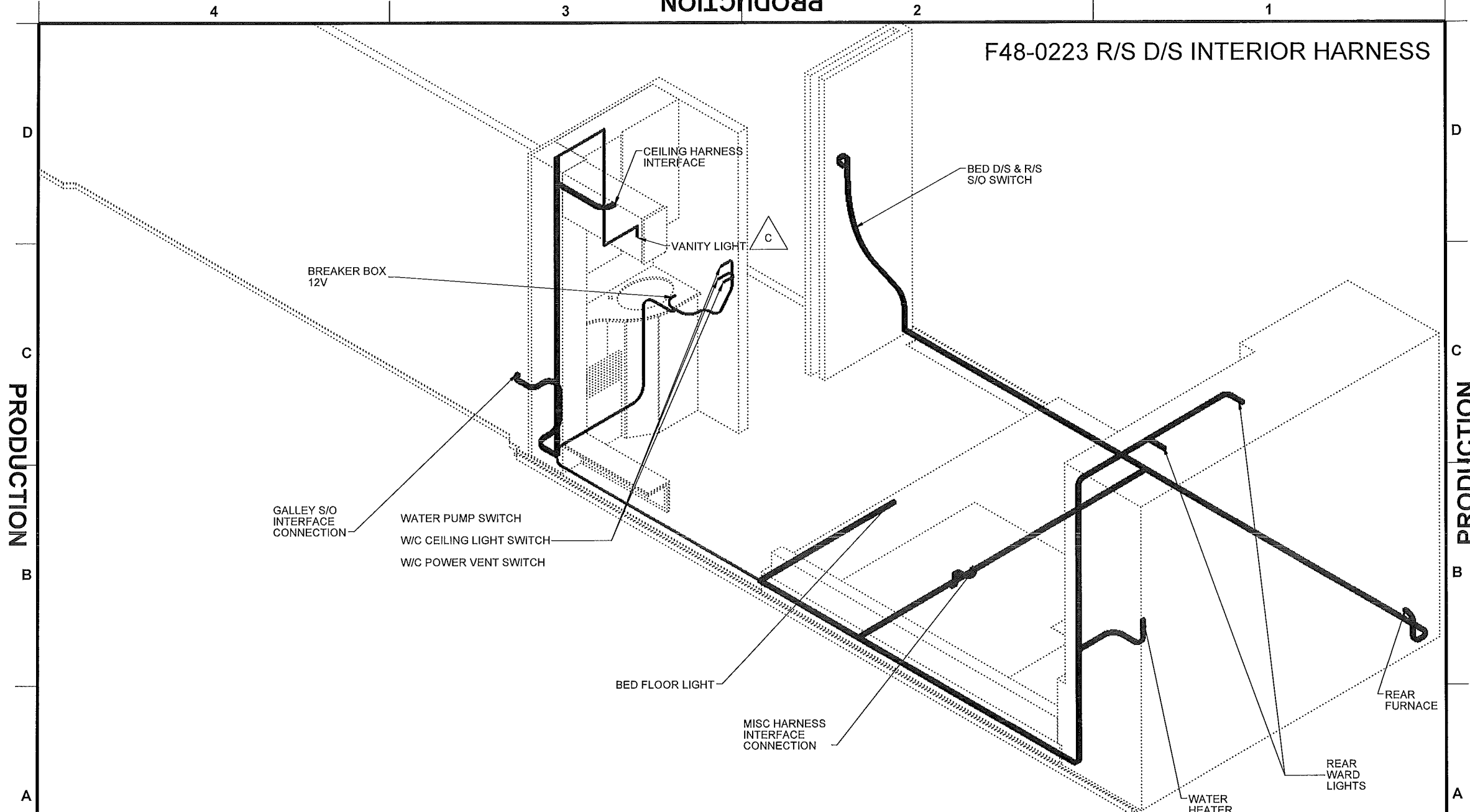

REVISIONS			
REV	DESCRIPTION	BY	RELEASED
E	CHANGED HARNESS PART NUMBERS	044smith	03/16/15
D	ADDED VANITY LT AND WATER CLOSET LT	044kipfef	03/07/14
B	<<Enter New Revision Description>>	044proffp	+

APPROVALS			
DRAWN	Admin	DATE	10/15/13
CHECKED	044smith	DATE	03/16/15
ENG APPR.	044smith	DATE	03/16/15
BOM APPR.	+	DATE	+
DSN APPR.	+	DATE	+

PROPRIETARY AND CONFIDENTIAL
 THIS MATERIAL IS PROPRIETARY TO FLEETWOOD RV, INC AND IS NOT TO BE USED BY THE RECIPIENT FOR ANY PURPOSE OTHER THAN THE PURPOSE FOR WHICH IT WAS TRANSMITTED. THE MATERIAL REMAINS THE PROPERTY OF FLEETWOOD RV, INC. AND SHALL BE RETURNED UPON REQUEST. THE MATERIAL MAY NOT BE REPRODUCED OR DISCLOSED TO THIRD PARTIES WITHOUT THE CONSENT OF FLEETWOOD RV, INC.

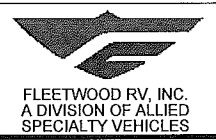

UNLESS OTHERWISE SPECIFIED
 TOLERANCES
 X.XX ±.03 FRACTIONS ± 1/32
 X.XXX ±.015 ANGLES ± 1°

TITLE HARNESS-12V ROUTING 770-37R
 UNITS OF MEASURE IN
 SCALE 1:96 SIZE B DWG NO. 19C00013

REV E SHEET 3 OF 9
 FILE 19C00013

PRODUCTION

R/S GALLEY S/O

- F48-0220 GALLEY S/O BASE
- F48-0154 GALLEY SIDEWALL
- F48-0221 GALLEY S/O O/H

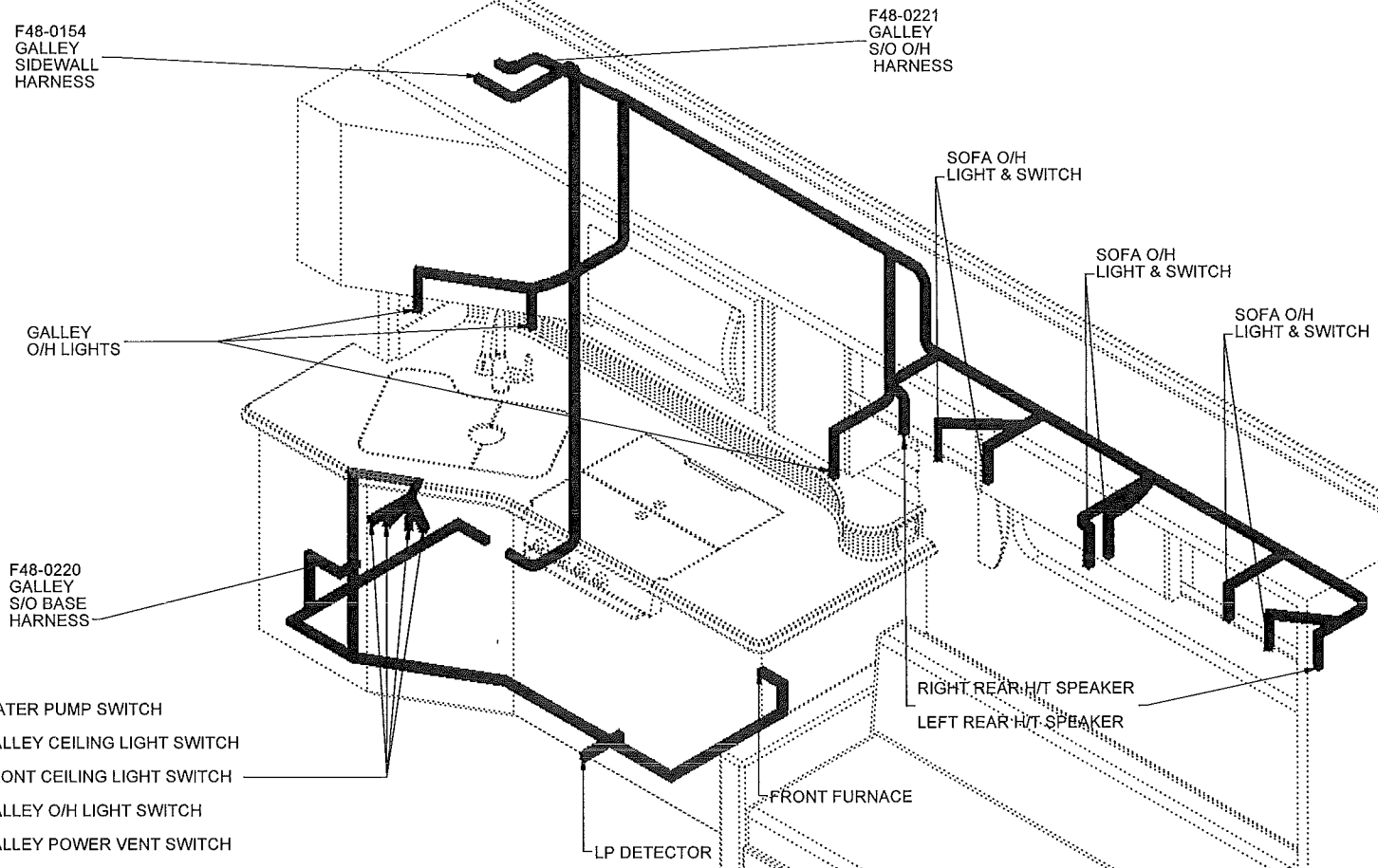

D
C
B
A
PRODUCTION

D
C
B
A
PRODUCTION

NOTES:
1. THIS COMPONENT MUST MEET OR EXCEED THE REQUIREMENTS OF FMVSS 302 AND/OR CMVSR 302

REVISIONS				APPROVALS			
REV	DESCRIPTION	BY	RELEASED	DRAWN	DATE	DATE	DATE
E	CHANGED HARNESS PART NUMBERS	044smithm	03/16/15	Admin	10/15/13	03/16/15	
D	ADDED VANITY LT AND WATER CLOSET LT	044kipfef	03/07/14	044smithm	03/16/15		
B	<<Enter New Revision Description>>	044proffp	+				

CHECKED	044smithm	DATE	03/16/15
ENG APPR.	044smithm	DATE	03/16/15
BOM APPR.	+	DATE	+
DSN APPR.	+	DATE	+

PROPRIETARY AND CONFIDENTIAL
THIS MATERIAL IS PROPRIETARY TO FLEETWOOD RV, INC AND IS NOT TO BE USED BY THE RECIPIENT FOR ANY PURPOSE OTHER THAN THE PURPOSE FOR WHICH IT WAS TRANSMITTED. THE MATERIAL REMAINS THE PROPERTY OF FLEETWOOD RV, INC. AND SHALL BE RETURNED UPON REQUEST. THE MATERIAL MAY NOT BE REPRODUCED OR DISCLOSED TO THIRD PARTIES WITHOUT THE CONSENT OF FLEETWOOD RV, INC.

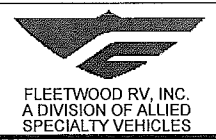

UNLESS OTHERWISE SPECIFIED
TOLERANCES
X.XX ± .03 FRACTIONS ± 1/32
X.XXX ± .016 ANGLES ± 1°
UNITS OF MEASURE IN

TITLE		HARNESS-12V ROUTING 770-37R	
SCALE	SIZE	DWG NO.	REV
1:24	B	19C00013	E
SHEET		OF	
4		9	
FILE		19C00013	

D/S LIVING S/O

 F48-0521 S/O LIVING

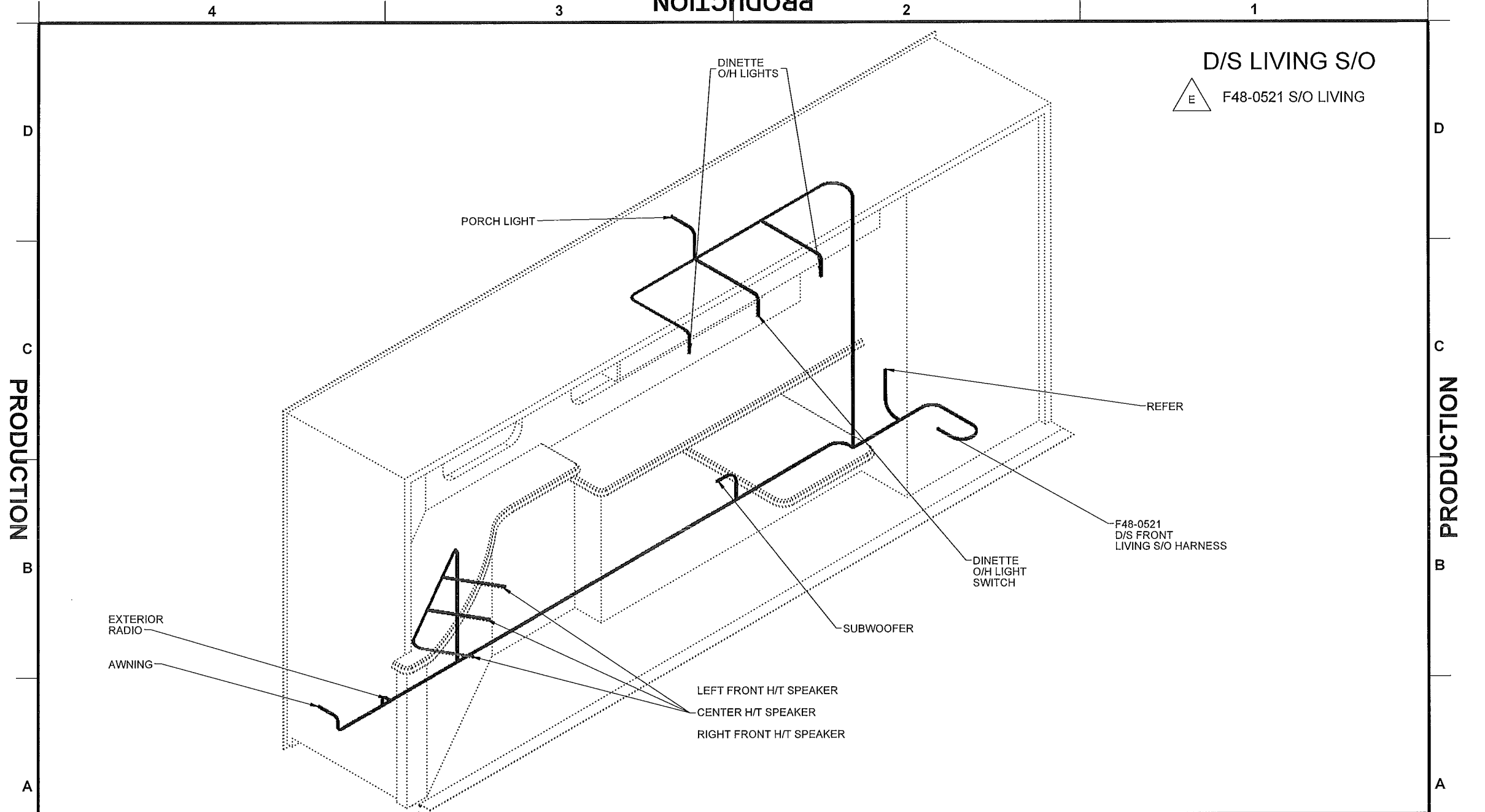

REVISIONS			
REV	DESCRIPTION	BY	RELEASED
E	CHANGED HARNESS PART NUMBERS	044smithm	03/16/15
D	ADDED VANITY LT AND WATER CLOSET LT	044kipfef	03/07/14
B	<<Enter New Revision Description>>	044proffp	+

APPROVALS			
DRAWN	Admin	DATE	10/15/13
CHECKED	044smithm	DATE	03/16/15
ENG APPR.	044smithm	DATE	03/16/15
BOM APPR.	+	DATE	+
DSN APPR.	+	DATE	+

PROPRIETARY AND CONFIDENTIAL
 THIS MATERIAL IS PROPRIETARY TO FLEETWOOD RV, INC AND IS NOT TO BE USED BY THE RECIPIENT FOR ANY PURPOSE OTHER THAN THE PURPOSE FOR WHICH IT WAS TRANSMITTED. THE MATERIAL REMAINS THE PROPERTY OF FLEETWOOD RV, INC. AND SHALL BE RETURNED UPON REQUEST. THE MATERIAL MAY NOT BE REPRODUCED OR DISCLOSED TO THIRD PARTIES WITHOUT THE CONSENT OF FLEETWOOD RV, INC.

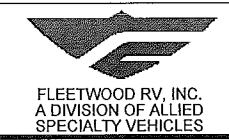

UNLESS OTHERWISE SPECIFIED
 TOLERANCES
 X.XX ±.03 FRACTIONS ± 1/32
 X.XXX ±.016 ANGLES ± 1°
 UNITS OF MEASURE IN 

TITLE HARNESS-12V ROUTING 770-37R
 SCALE 1:24 SIZE B DWG NO. 19C00013

REV E SHEET 5 OF 9
 FILE 19C00013

D/S BED S/O

F48-0213 DRESSER S/O
F48-0198 DRESSER CEILING

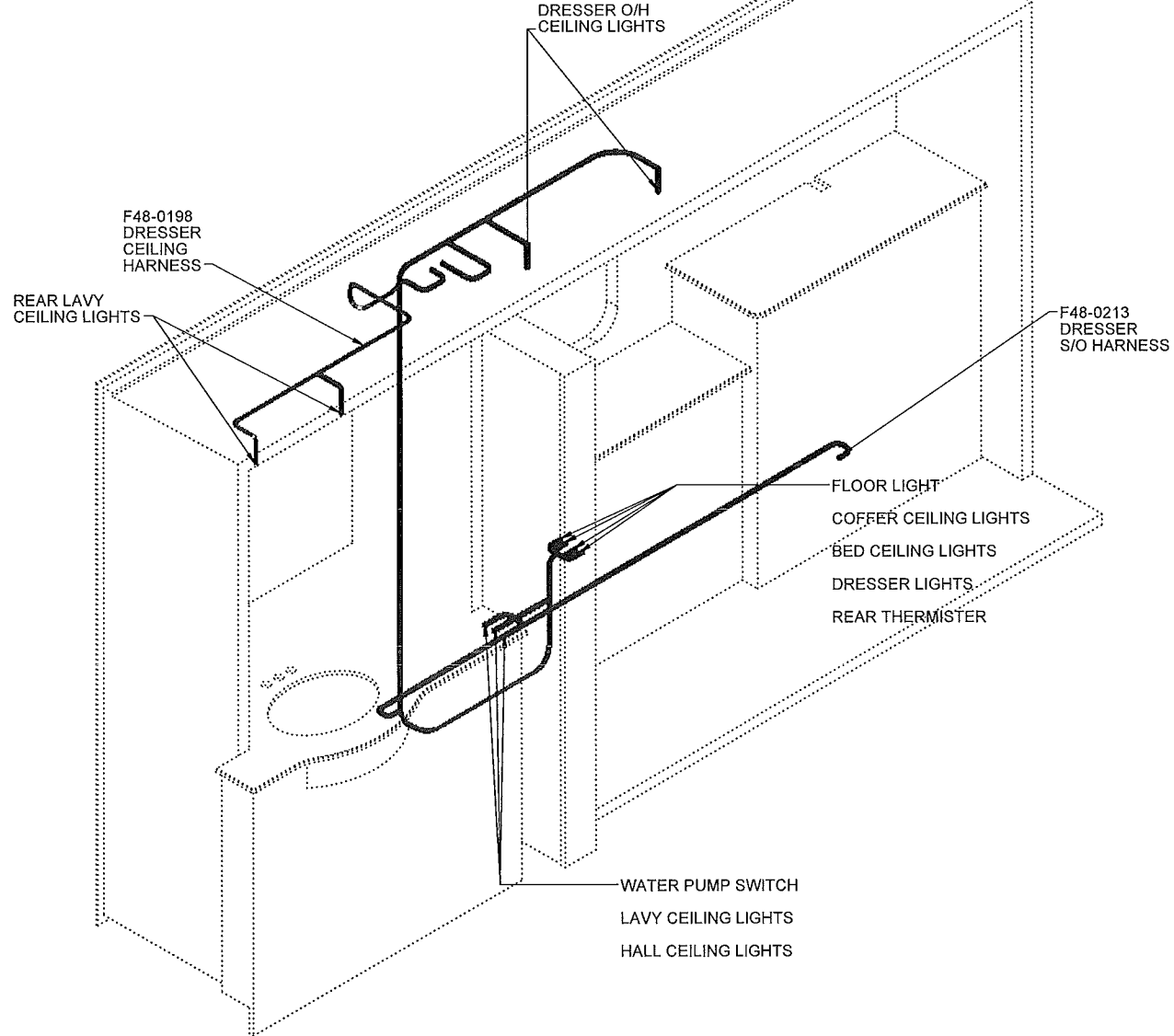

D
C
B
A
PRODUCTION

D
C
B
A
PRODUCTION

REVISIONS				APPROVALS			<small>PROPRIETARY AND CONFIDENTIAL</small> THIS MATERIAL IS PROPRIETARY TO FLEETWOOD RV, INC AND IS NOT TO BE USED BY THE RECIPIENT FOR ANY PURPOSE OTHER THAN THE PURPOSE FOR WHICH IT WAS TRANSMITTED. THE MATERIAL REMAINS THE PROPERTY OF FLEETWOOD RV, INC. AND SHALL BE RETURNED UPON REQUEST. THE MATERIAL MAY NOT BE REPRODUCED OR DISCLOSED TO THIRD PARTIES WITHOUT THE CONSENT OF FLEETWOOD RV, INC.	UNLESS OTHERWISE SPECIFIED		TITLE	
REV	DESCRIPTION	BY	RELEASED	DRAWN	DATE	TOLERANCES		SCALE	SIZE	DWG NO.	REV
E	CHANGED HARNESS PART NUMBERS	044smithm	03/16/15	Admin	10/15/13	XX ± .03 FRACTIONS ± 1/32 X.XXX ± .015 ANGLES ± 1°	1:384	B	19C00013	E	
D	ADDED VANITY LT AND WATER CLOSET LT	044kipfef	03/07/14	044smithm	03/16/15					6	
B	<<Enter New Revision Description>>	044proffp	+	BOM APPR.	+					OF 9	
				DSN APPR.	+					FILE 19C00013	

DC INFO
703_16-34_04272015

R/S BED S/O

- F48-0009 BED S/O O/H HARNESS
- F48-3480 BED S/O WALL HARNESS
- F48-0059 BED S/O INTERFACE HARNESS

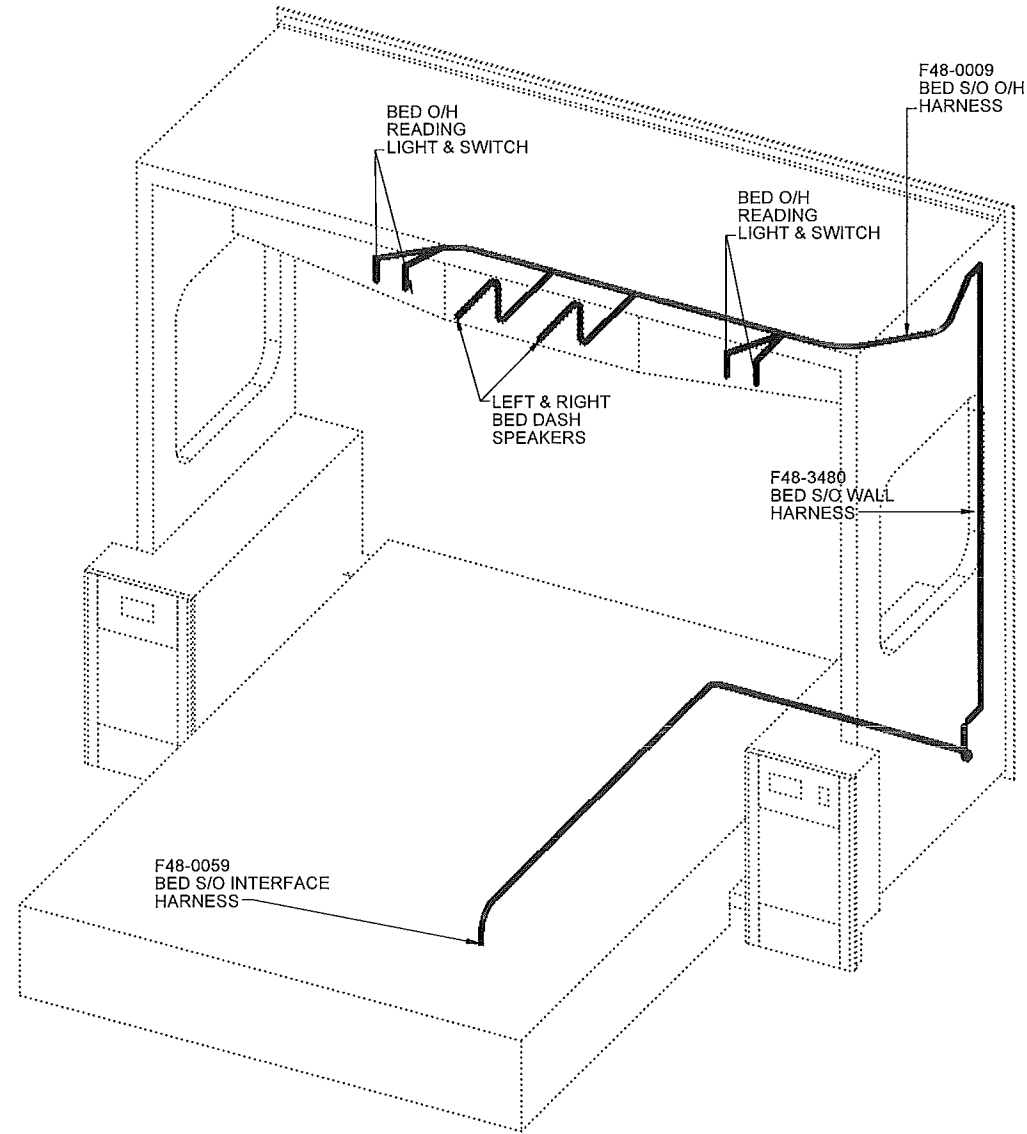

PRODUCTION

PRODUCTION

REVISIONS				APPROVALS			
REV	DESCRIPTION	BY	RELEASED	DRAWN	Admin	DATE	10/15/13
E	CHANGED HARNESS PART NUMBERS	044smithm	03/16/15	CHECKED	044smithm	DATE	03/16/15
D	ADDED VANITY LT AND WATER CLOSET LT	044kipfef	03/07/14	ENG APPR.	044smithm	DATE	03/16/15
B	<<Enter New Revision Description>>	044proffp	+	BOM APPR.		DATE	+
				DSN APPR.		DATE	+

UNITS OF MEASURE	IN
------------------	----

PROPRIETARY AND CONFIDENTIAL
 THIS MATERIAL IS PROPRIETARY TO FLEETWOOD RV, INC AND IS NOT TO BE USED BY THE RECIPIENT FOR ANY PURPOSE OTHER THAN THE PURPOSE FOR WHICH IT WAS TRANSMITTED. THE MATERIAL REMAINS THE PROPERTY OF FLEETWOOD RV, INC. AND SHALL BE RETURNED UPON REQUEST. THE MATERIAL MAY NOT BE REPRODUCED OR DISCLOSED TO THIRD PARTIES WITHOUT THE CONSENT OF FLEETWOOD RV, INC.

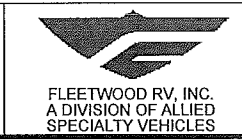

UNLESS OTHERWISE SPECIFIED	TOLERANCES
X.XX ±.03	FRACTIONS ± 1/32
X.XXX ±.015	ANGLES ± 1°

TITLE	HARNESS-12V ROUTING 770-37R		
SCALE	SIZE	DWG NO.	REV
1:384	B	19C00013	E

SHEET	7	OF	9
-------	---	----	---

CEILING

 F48-0522 CEILING HARNESS

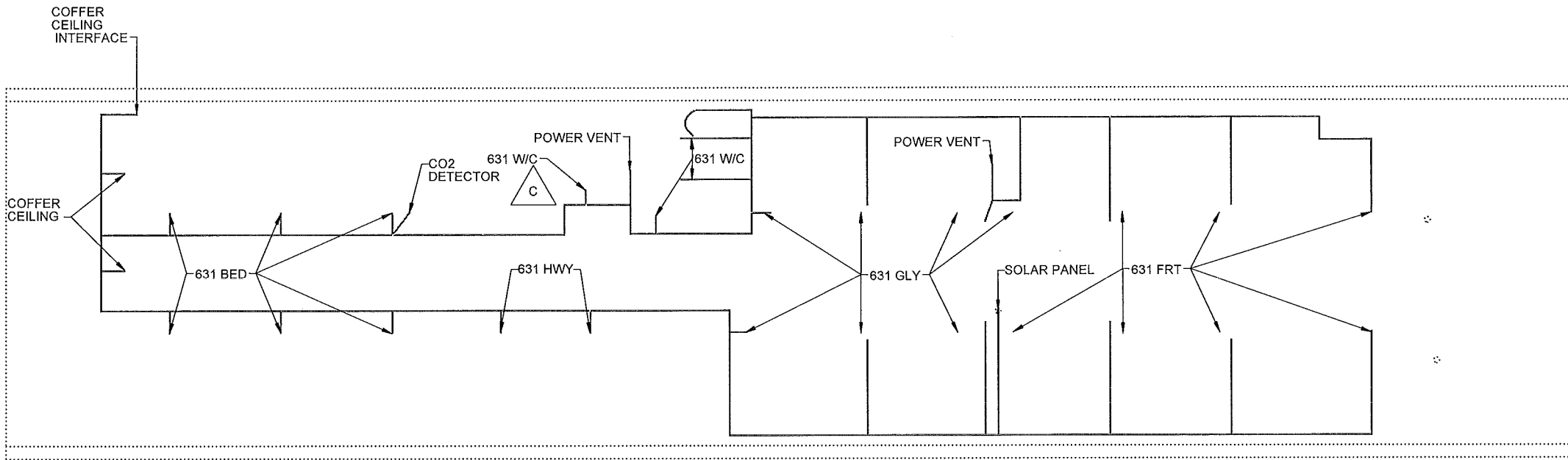

PRODUCTION

PRODUCTION

REVISIONS			
REV	DESCRIPTION	BY	RELEASED
E	CHANGED HARNESS PART NUMBERS	044smithm	03/16/15
D	ADDED VANITY LT AND WATER CLOSET LT	044kipfef	03/07/14
B	<<Enter New Revision Description>>	044proffp	+

APPROVALS			
DRAWN	Admin	DATE	10/15/13
CHECKED	044smithm	DATE	03/16/15
ENG APPR.	044smithm	DATE	03/16/15
BOM APPR.	+	DATE	+
DSN APPR.	+	DATE	+

PROPRIETARY AND CONFIDENTIAL
 THIS MATERIAL IS PROPRIETARY TO FLEETWOOD RV, INC. AND IS NOT TO BE USED BY THE RECIPIENT FOR ANY PURPOSE OTHER THAN THE PURPOSE FOR WHICH IT WAS TRANSMITTED. THE MATERIAL REMAINS THE PROPERTY OF FLEETWOOD RV, INC. AND SHALL BE RETURNED UPON REQUEST. THE MATERIAL MAY NOT BE REPRODUCED OR DISCLOSED TO THIRD PARTIES WITHOUT THE CONSENT OF FLEETWOOD RV, INC.



UNLESS OTHERWISE SPECIFIED	
TOLERANCES	
X.XX ±.03	FRACTIONS ± 1/32
X.XXX ±.015	ANGLES ±1°
UNITS OF MEASURE	 IN

TITLE		HARNESS-12V ROUTING 770-37R	
SCALE	SIZE	DWG NO.	REV
1:96	B	19C00013	E
SHEET			OF
8			9
FILE			
19C00013			

BED COFFER CEILING

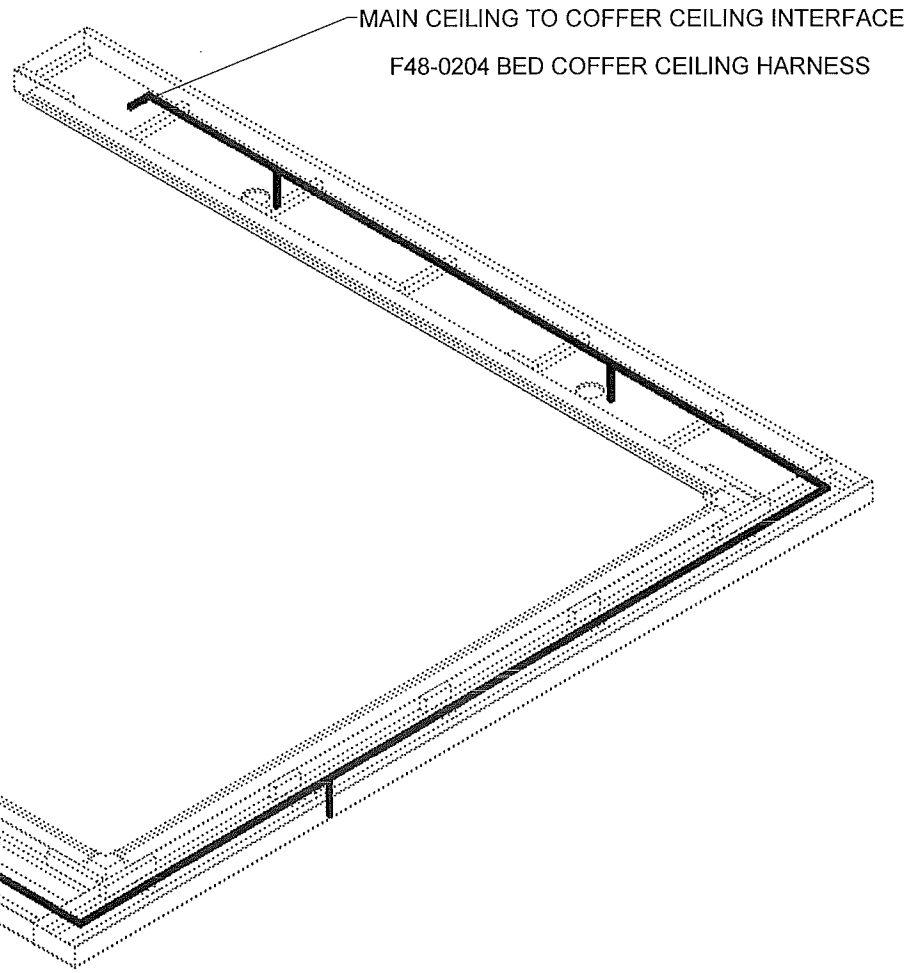

PRODUCTION

PRODUCTION

REVISIONS				APPROVALS			<small>PROPRIETARY AND CONFIDENTIAL</small> THIS MATERIAL IS PROPRIETARY TO FLEETWOOD RV, INC AND IS NOT TO BE USED BY THE RECIPIENT FOR ANY PURPOSE OTHER THAN THE PURPOSE FOR WHICH IT WAS TRANSMITTED. THE MATERIAL REMAINS THE PROPERTY OF FLEETWOOD RV, INC AND SHALL BE RETURNED UPON REQUEST. THE MATERIAL MAY NOT BE REPRODUCED OR DISCLOSED TO THIRD PARTIES WITHOUT THE CONSENT OF FLEETWOOD RV, INC.	UNLESS OTHERWISE SPECIFIED		TITLE	
REV	DESCRIPTION	BY	RELEASED	DRAWN	DATE	TOLERANCES		SCALE	SIZE	DWG NO.	REV
E	CHANGED HARNESS PART NUMBERS	044smithm	03/16/15	CHECKED	044smithm	DATE	03/16/15	XXX ± .03	FRACTIONS ± 1/32		
D	ADDED VANITY LT AND WATER CLOSET LT	044kipfef	03/07/14	ENG APPR.	044smithm	DATE	03/16/15	XXX ± .015	ANGLES ± 1°		
B	<<Enter New Revision Description>>	044proffp	+	BOM APPR.		DATE	+	UNITS OF MEASURE IN		SCALE 1:96	SIZE B
				DSN APPR.		DATE	+	DWG NO. 19C00013		REV E	SHEET 9 OF 9
DC INFO 703_16-34_04272015							FILE 19C00013				